

Pompe centrifughe normalizzate "EN 733"

 Acque pulite

 Uso industriale



CAMPO DELLE PRESTAZIONI

- Portata fino a **6000 l/min** (360 m³/h)
- Prevalenza fino a **98 m**

LIMITI D'IMPIEGO

- Altezza d'aspirazione manometrica fino a **7 m**
- Temperatura del liquido da **-10 °C** fino a **+90 °C**
- Pressione max. nel corpo pompa **10 bar** (PN10)

ESECUZIONE E NORME DI SICUREZZA

EN 733



REGOLAMENTO (UE) N. 547/2012

CERTIFICAZIONI

Azienda con sistema di gestione certificato DNV
ISO 9001: QUALITÀ
ISO 14001: AMBIENTE



UTILIZZI E INSTALLAZIONI

- Approvvigionamento idrico
- Pressurizzazione
- Irrigazione
- Circolazione acqua in impianti di climatizzazione
- Impianti di lavaggio
- Impianti antincendio
- Industria
- Agricoltura

ESECUZIONI A RICHIESTA

- KIT controflange comprensivo di viti, dadi e guarnizioni
- Tenuta meccanica speciale
- Pompe per motori con frequenza 60 Hz
- Per liquidi con temperature più alte o più basse
- Per ambienti con temperature più alte o più basse

GARANZIA

2 anni secondo le nostre condizioni generali di vendita

CAMPO DI PRESTAZIONI

n= 2900 rpm

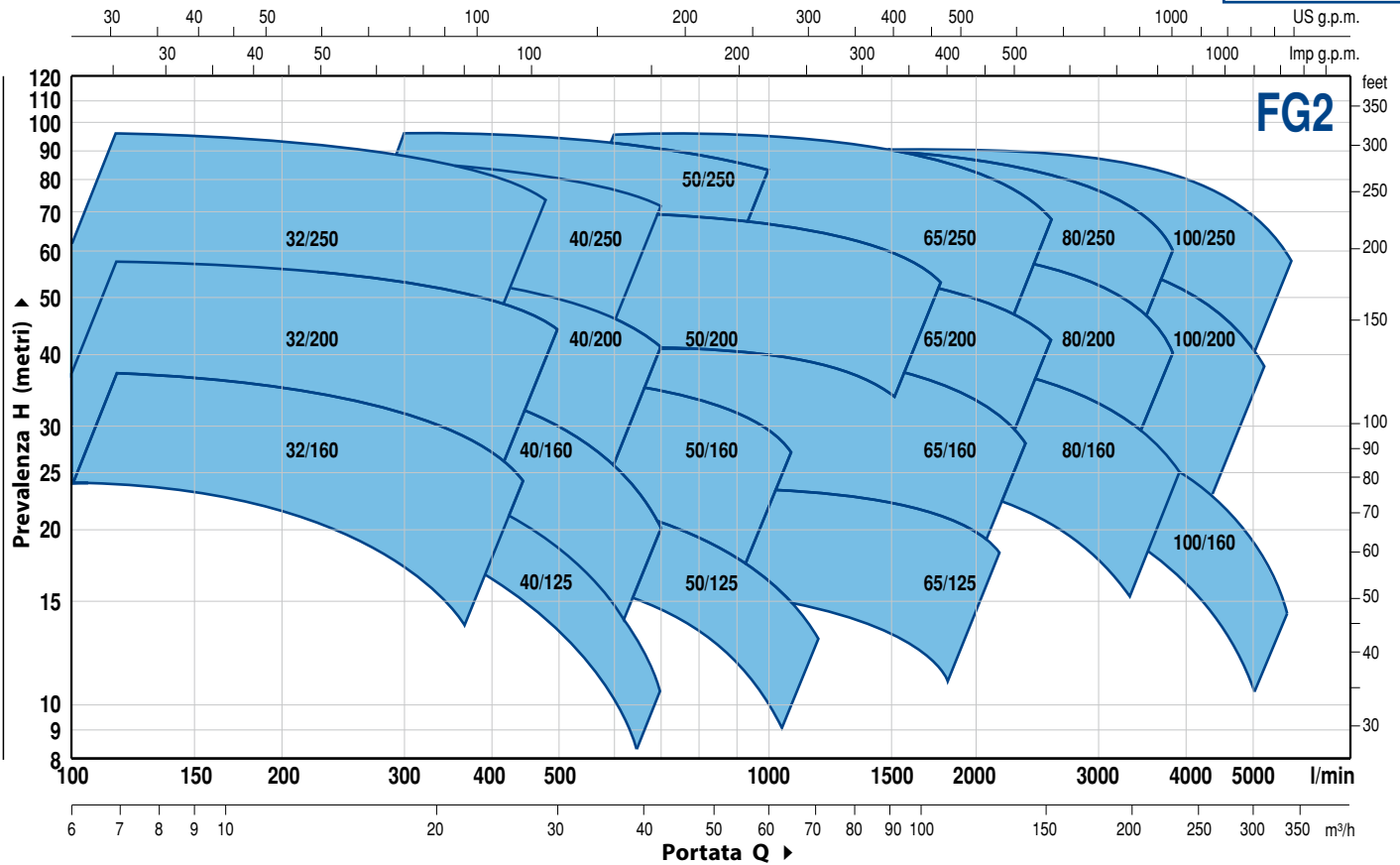

DATI DI PRESTAZIONI

TIPO	MOTORE DA ACCOPPIARE		PRESTAZIONI n= 2900 rpm	
	kW	HP	Q m ³ /h	H metri
FG2-32/160C	1.5	2	6 ÷ 21	24 ÷ 14
FG2-32/160B	2.2	3	6 ÷ 24	30 ÷ 17
FG2-32/160A	3	4	6 ÷ 27	37 ÷ 24
FG2-32/200C	4	5.5	6 ÷ 27	44 ÷ 31.5
FG2-32/200B	5.5	7.5	6 ÷ 30	51 ÷ 36
FG2-32/200A	7.5	10	6 ÷ 30	57 ÷ 44
FG2-32/200BH	3	4	6 ÷ 18	45 ÷ 37
FG2-32/200AH	4	5.5	6 ÷ 19.2	55 ÷ 44
FG2-32/250C	9.2	12.5	6 ÷ 24	75 ÷ 55
FG2-32/250B	11	15	6 ÷ 27	87 ÷ 62
FG2-32/250A	15	20	6 ÷ 28.8	97 ÷ 70
FG2-40/125C	1.1	1.5	6 ÷ 33	16 ÷ 6
FG2-40/125B	1.5	2	6 ÷ 36	20.5 ÷ 9
FG2-40/125A	2.2	3	6 ÷ 42	26 ÷ 10
FG2-40/160C	2.2	3	6 ÷ 36	27 ÷ 14
FG2-40/160B	3	4	6 ÷ 36	32 ÷ 20
FG2-40/160A	4	5.5	6 ÷ 42	38 ÷ 20
FG2-40/200B	5.5	7.5	6 ÷ 42	47 ÷ 28
FG2-40/200A	7.5	10	6 ÷ 42	55 ÷ 41
FG2-40/250C	9.2	12.5	6 ÷ 42	64 ÷ 47
FG2-40/250B	11	15	6 ÷ 42	71 ÷ 55
FG2-40/250A	15	20	6 ÷ 42	88 ÷ 72
FG2-50/125C	2.2	3	18 ÷ 72	17.5 ÷ 6
FG2-50/125B	3	4	18 ÷ 72	20.7 ÷ 9
FG2-50/125A	4	5.5	18 ÷ 72	23.5 ÷ 13
FG2-50/160C	4	5.5	18 ÷ 60	27 ÷ 16
FG2-50/160B	5.5	7.5	18 ÷ 66	32 ÷ 21
FG2-50/160A	7.5	10	18 ÷ 66	37 ÷ 27
FG2-50/200C	11	15	24 ÷ 102	44 ÷ 30
FG2-50/200B	15	20	24 ÷ 102	52 ÷ 38
FG2-50/200A	18.5	25	24 ÷ 108	61 ÷ 45
FG2-50/200AR	22	30	24 ÷ 108	69 ÷ 53
FG2-50/250D	9.2	12.5	18 ÷ 54	51 ÷ 32
FG2-50/250C	11	15	18 ÷ 54	59 ÷ 42
FG2-50/250B	15	20	18 ÷ 60	72 ÷ 59
FG2-50/250A	18.5	25	18 ÷ 60	85 ÷ 73
FG2-50/250AR	22	30	18 ÷ 60	95 ÷ 83

TIPO	MOTORE DA ACCOPPIARE		PRESTAZIONI n= 2900 rpm	
	kW	HP	Q m ³ /h	H metri
FG2-65/125C	4	5.5	36 ÷ 108	16 ÷ 11
FG2-65/125B	5.5	7.5	36 ÷ 108	18 ÷ 13
FG2-65/125A	7.5	10	36 ÷ 132	23 ÷ 18
FG2-65/160C	9.2	12.5	36 ÷ 132	32 ÷ 22
FG2-65/160B	11	15	36 ÷ 144	36.5 ÷ 23
FG2-65/160A	15	20	36 ÷ 144	40.5 ÷ 28
FG2-65/200B	15	20	12 ÷ 144	44 ÷ 30.5
FG2-65/200A	18.5	25	12 ÷ 150	50 ÷ 36.5
FG2-65/200AR	22	30	12 ÷ 156	57 ÷ 42
FG2-65/250C	30	40	24 ÷ 141	76 ÷ 53
FG2-65/250B	37	50	24 ÷ 150	87 ÷ 62
FG2-65/250A	45	60	24 ÷ 156	95 ÷ 68
FG2-80/160D	11	15	30 ÷ 240	25 ÷ 10
FG2-80/160C	15	20	30 ÷ 240	30 ÷ 15
FG2-80/160B	18.5	25	30 ÷ 240	35 ÷ 20
FG2-80/160A	22	30	30 ÷ 240	40 ÷ 25
FG2-80/200B	30	40	30 ÷ 219	56 ÷ 34.5
FG2-80/200A	37	50	30 ÷ 234	62 ÷ 40
FG2-80/250B	45	60	36 ÷ 216	77 ÷ 54
FG2-80/250A	55	75	36 ÷ 234	88.5 ÷ 60
FG2-100/160C-N	15	20	60 ÷ 300	28.5 ÷ 11
FG2-100/160B-N	18.5	25	60 ÷ 330	32.5 ÷ 11
FG2-100/160A-N	22	30	60 ÷ 360	37 ÷ 13
FG2-100/200C	30	40	48 ÷ 279	51 ÷ 28
FG2-100/200B	37	50	48 ÷ 294	57 ÷ 33
FG2-100/200A	45	60	48 ÷ 315	63 ÷ 38
FG2-100/250B	55	75	48 ÷ 309	75 ÷ 48
FG2-100/250A	75	100	48 ÷ 345	89 ÷ 58

Q = Portata

H = Prevalenza manometrica totale

Tolleranza delle curve di prestazioni secondo EN ISO 9906 Grado 3B.

FG2-32/160

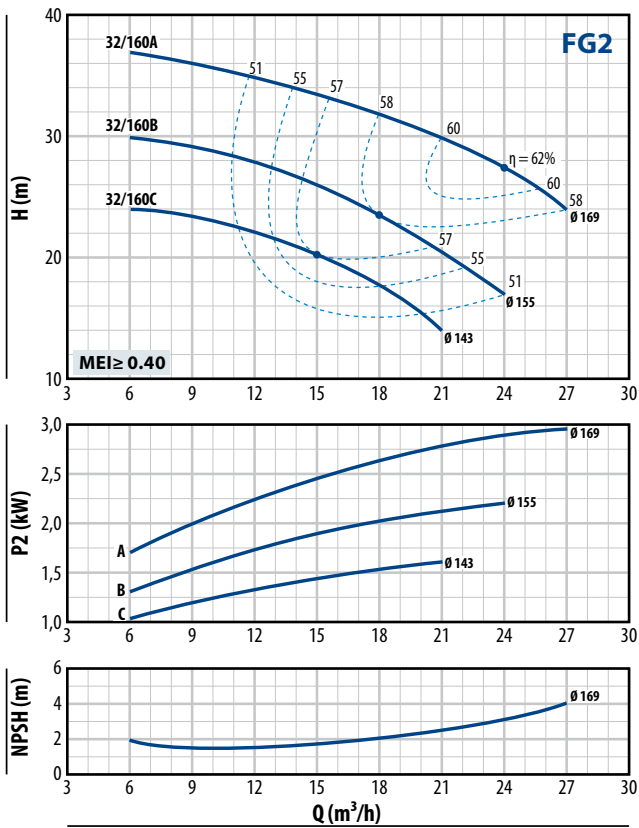

FG2-32/200

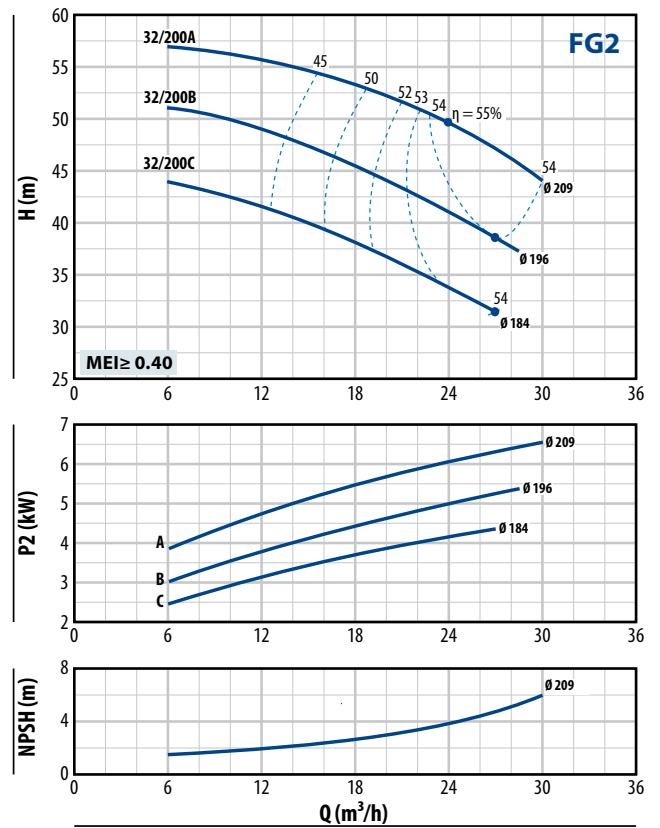

FG2-32/200H

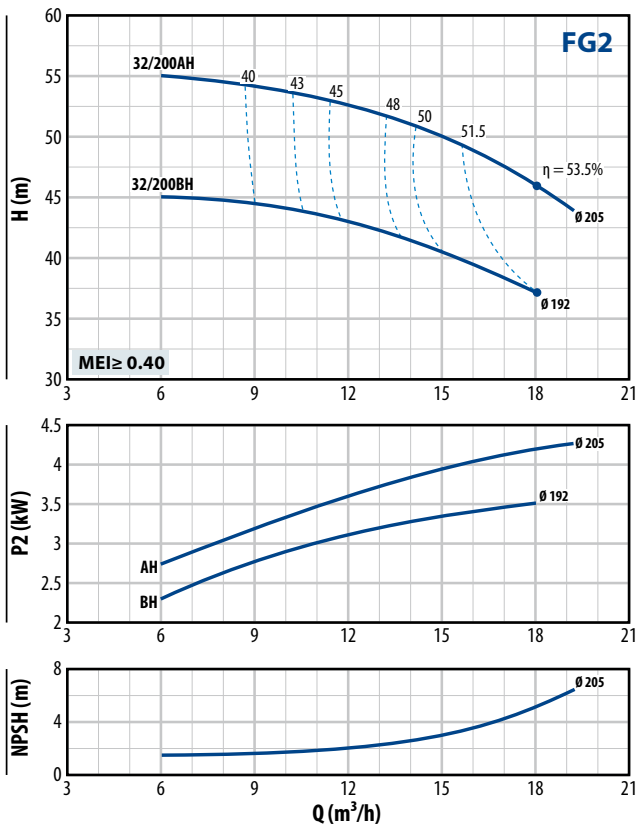

FG2-32/250

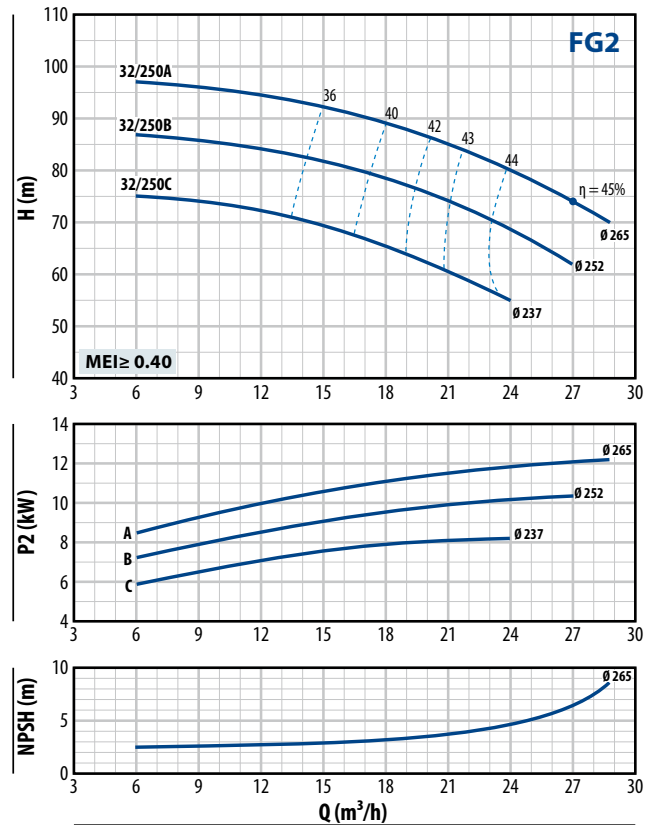

CURVE DI PRESTAZIONE

n = 2900 rpm

FG2-40/125

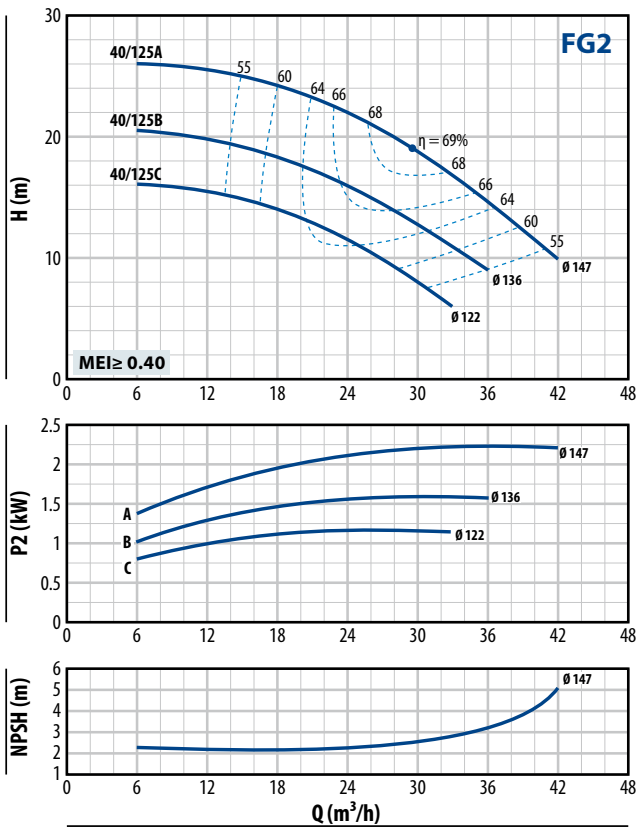

FG2-40/160

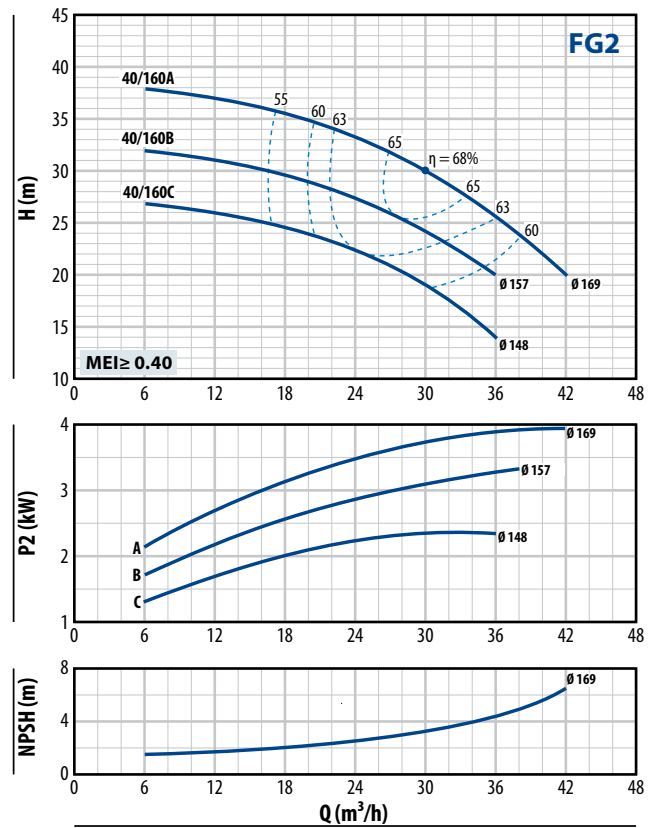

FG2-40/200

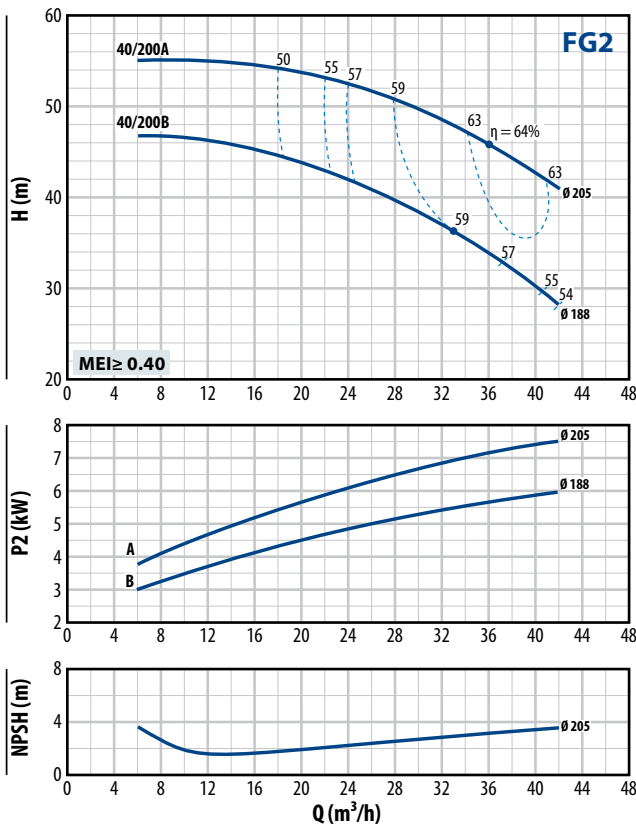

FG2-40/250

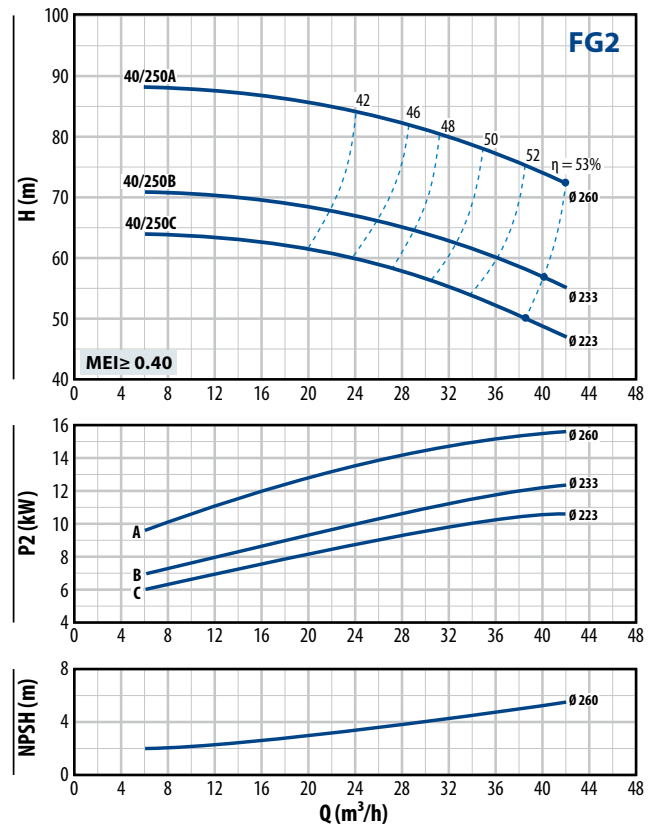

FG2-50/125

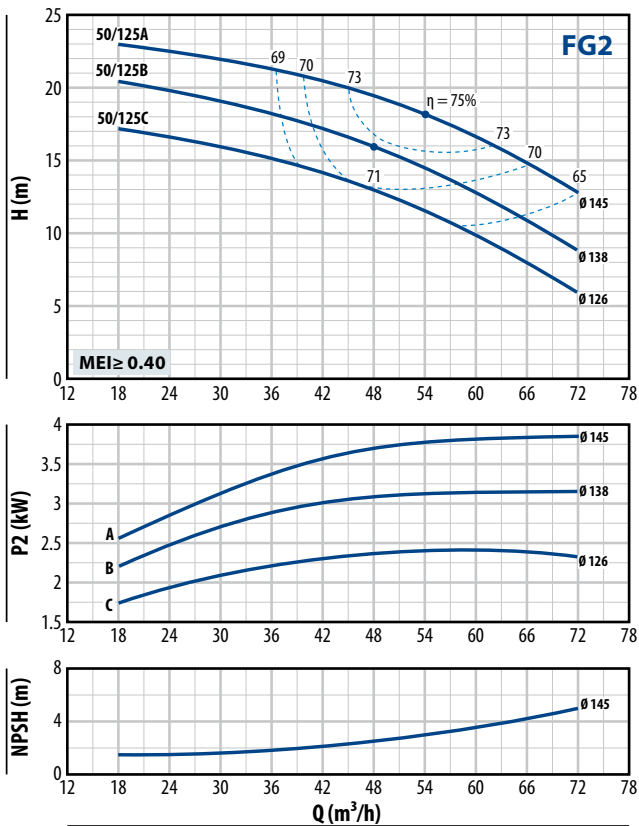

FG2-50/160

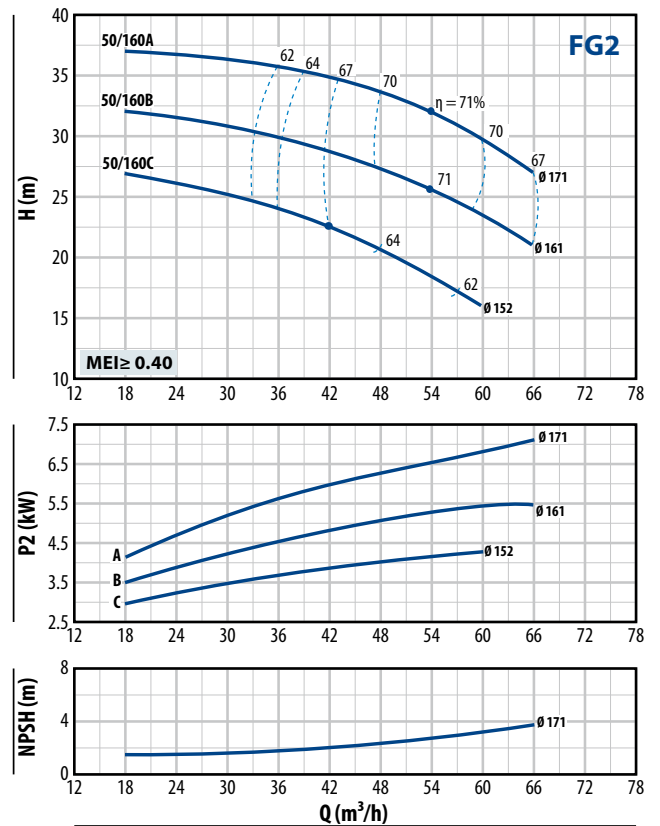

FG2-50/200

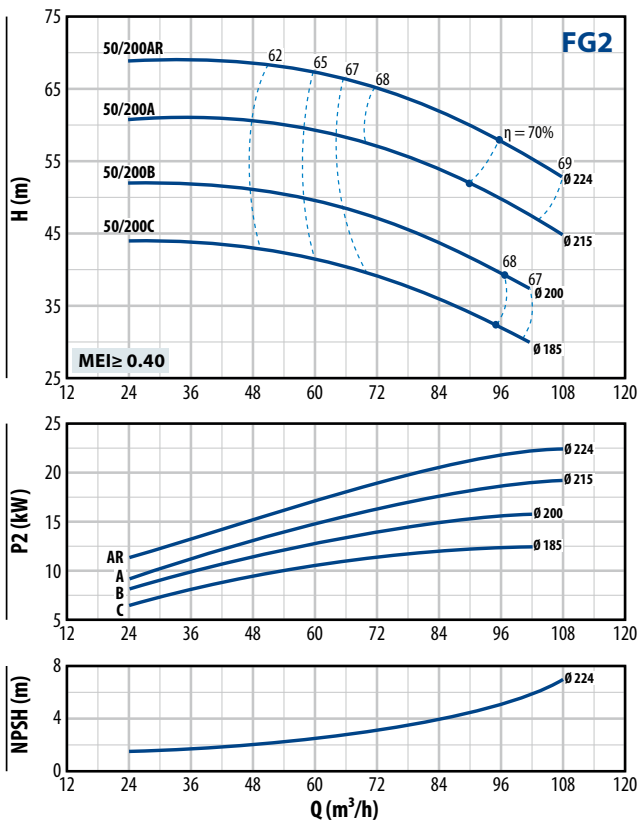

FG2-50/250

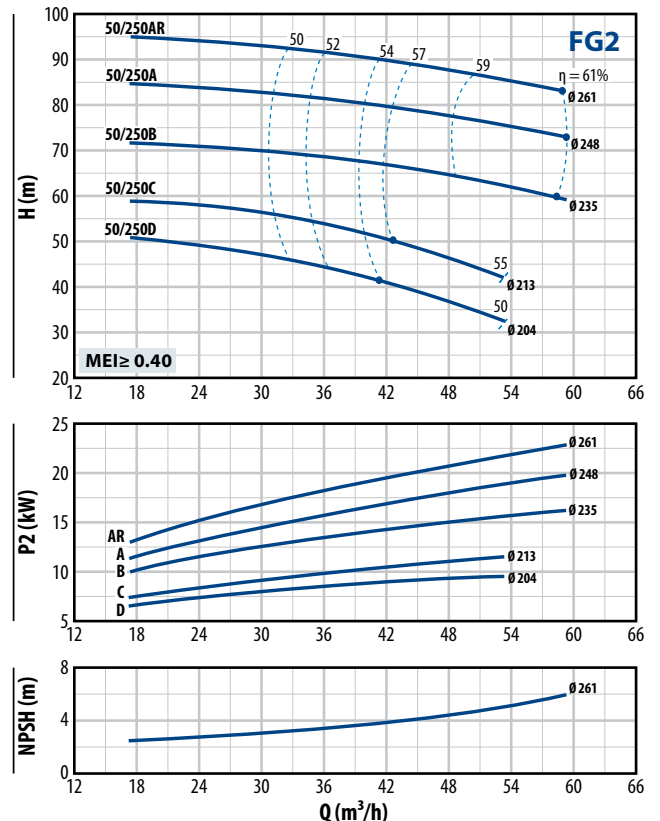

FG2-65/125

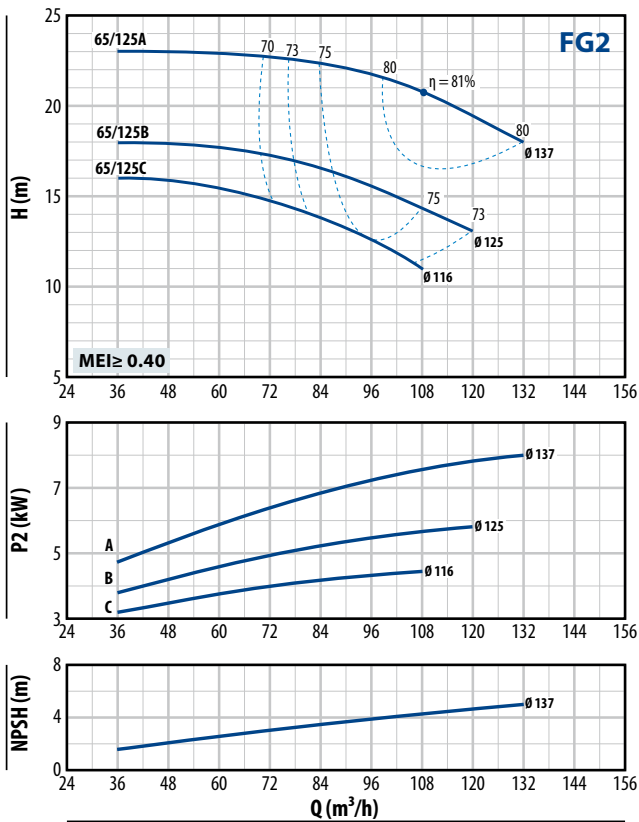

FG2-65/160

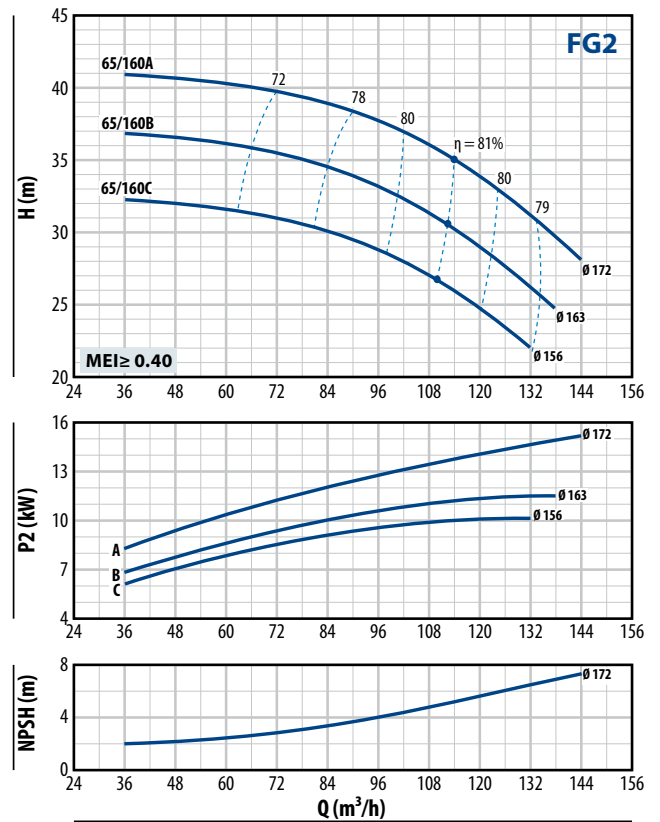

FG2-65/200

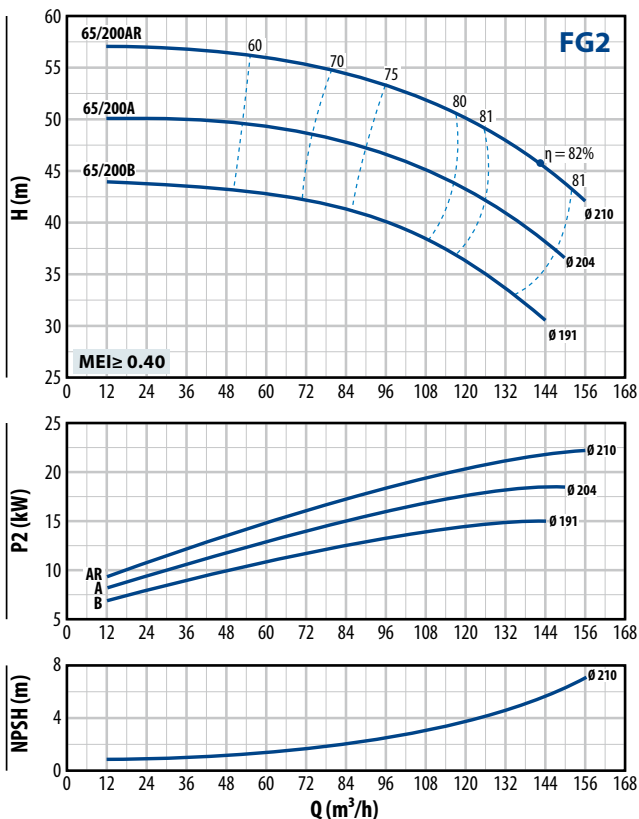

FG2-65/250

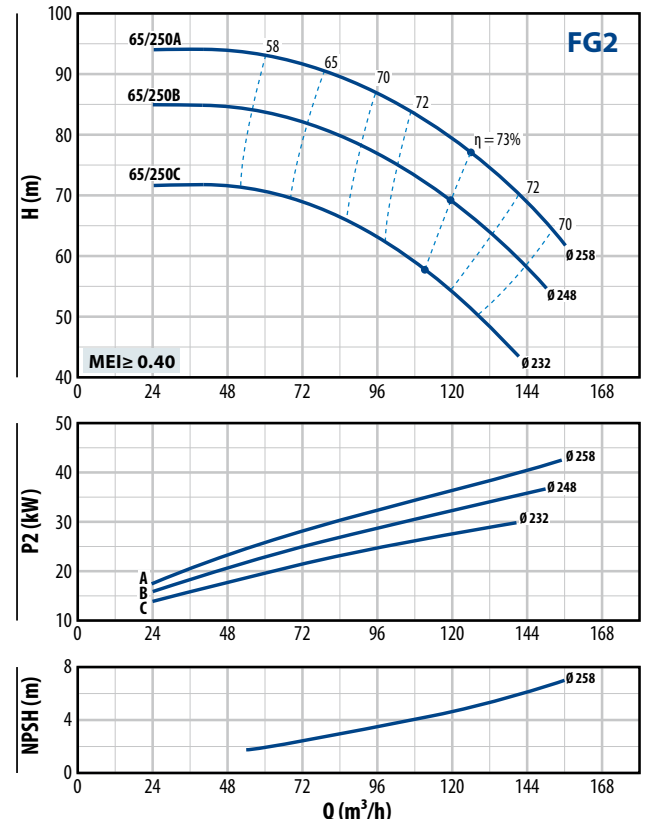

FG2-80/160

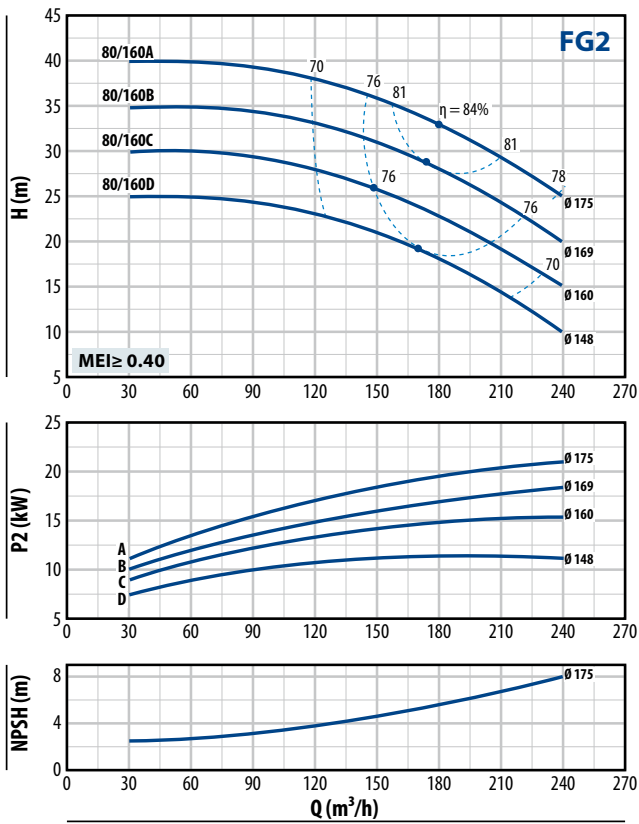

FG2-80/200

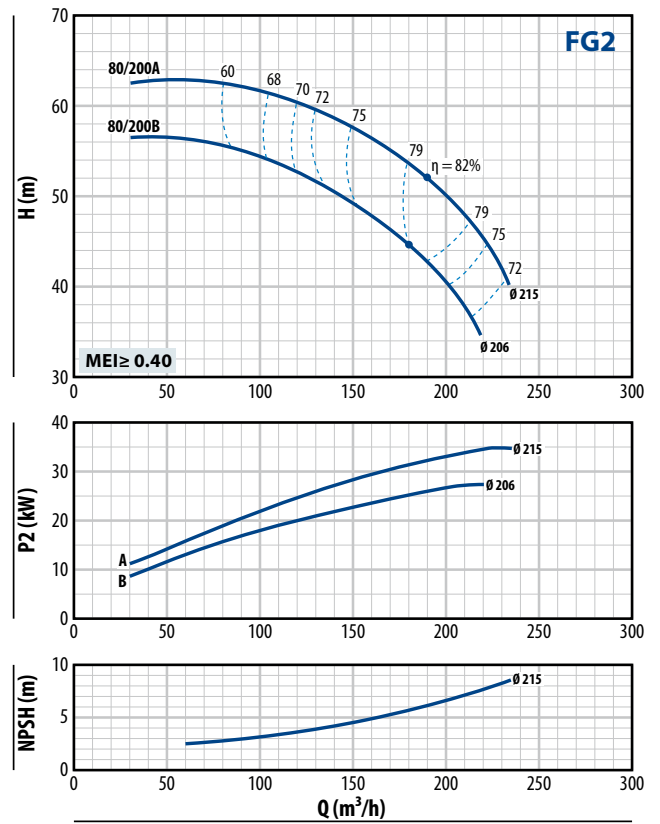

FG2-80/250

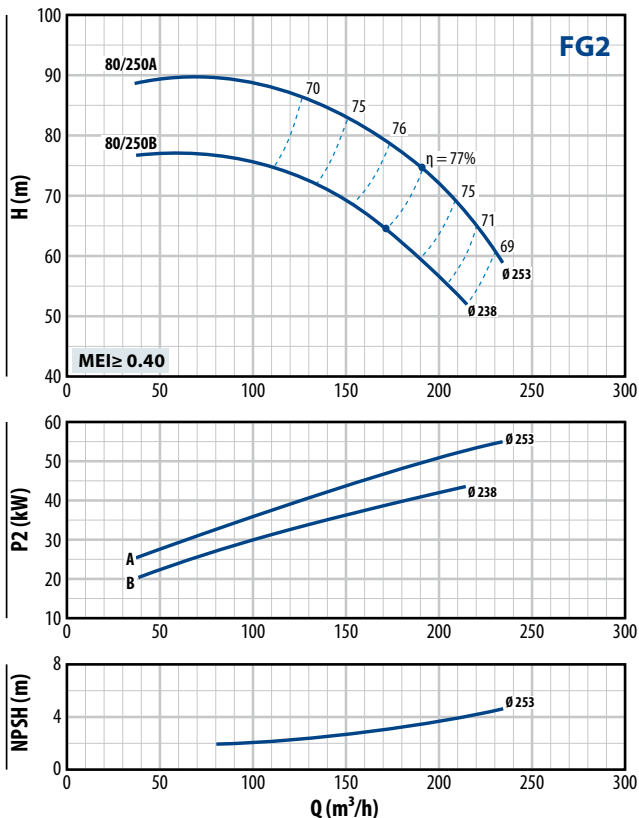

CURVE DI PRESTAZIONE

n = 2900 rpm

FG2-100/160

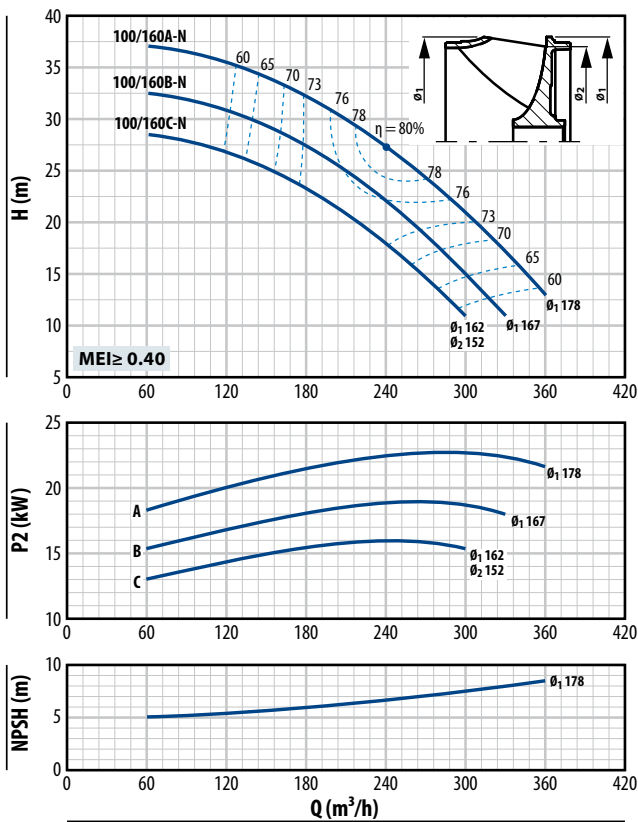

FG2-100/200

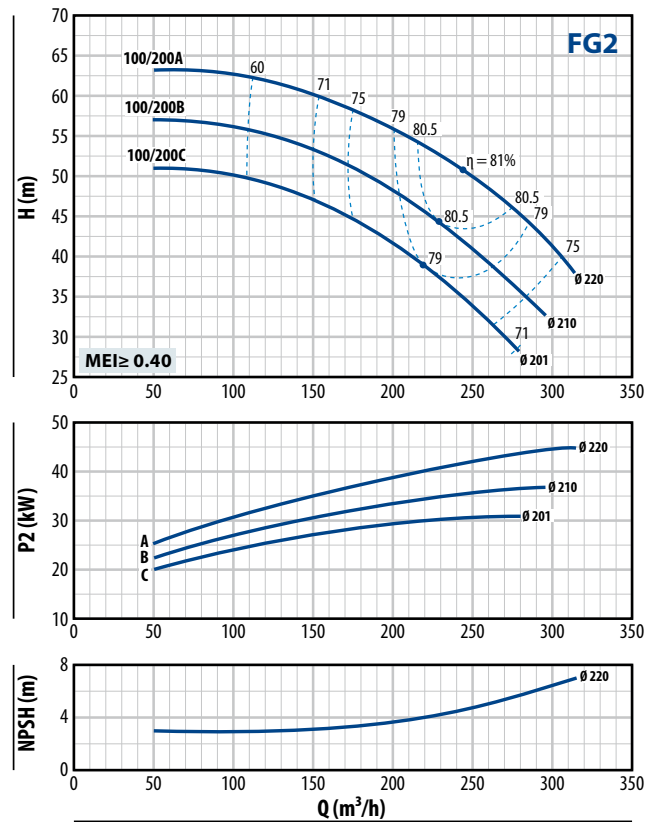

FG2-100/250

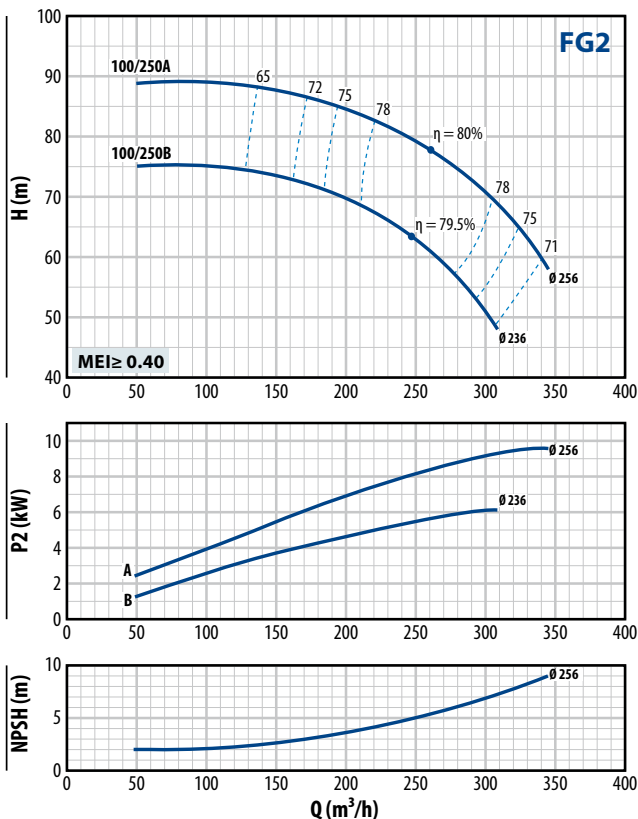

CAMPO DI PRESTAZIONI

n = 1450 rpm

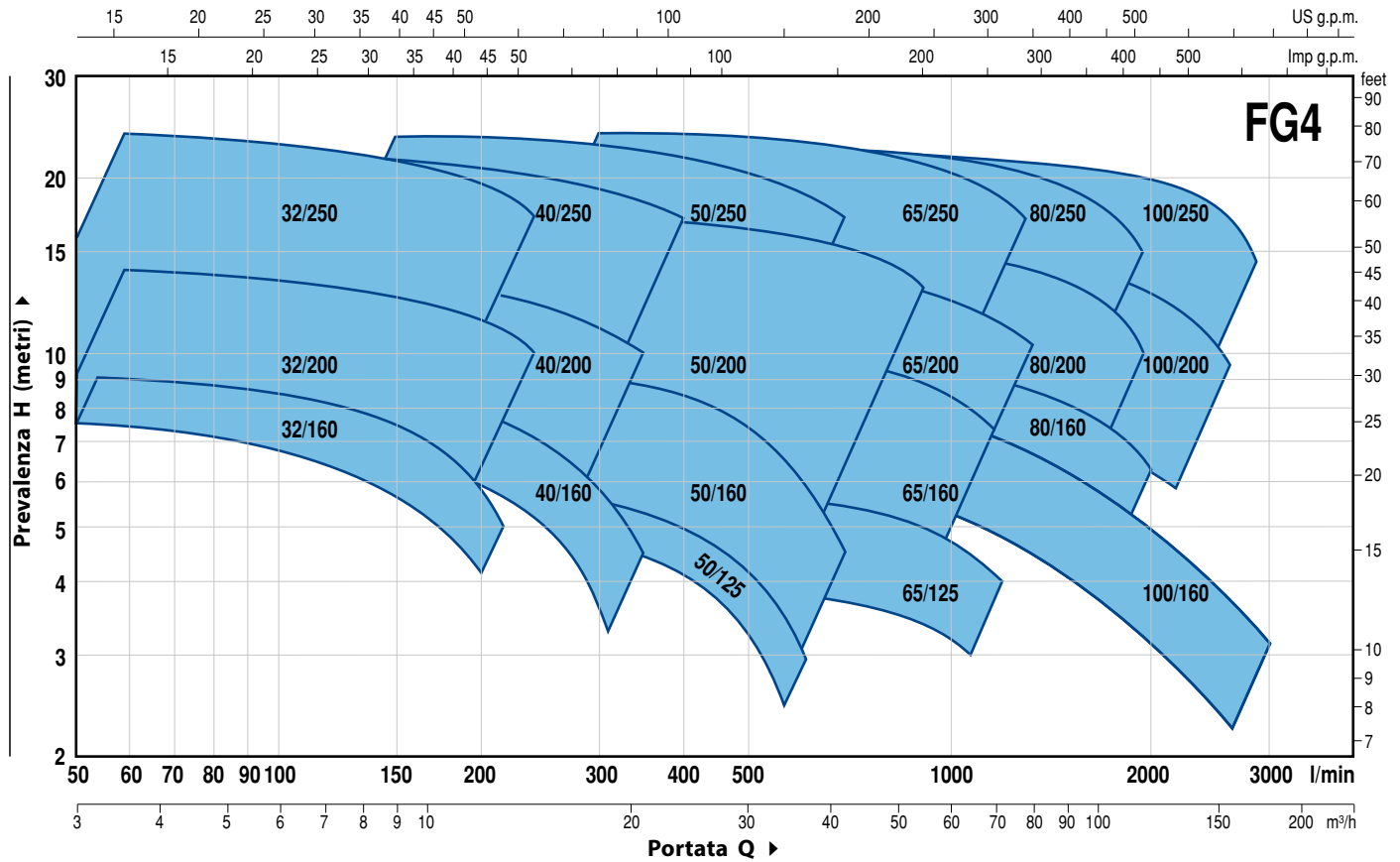

DATI DI PRESTAZIONI

TIPO	MOTORE DA ACCOPIARE		PRESTAZIONI n = 1450 rpm	
	kW	HP	Q m³/h	H metri
FG4-32/160C	0.25	0.33	3 ÷ 10.5	6 ÷ 3.5
FG4-32/160B	0.37	0.5	3 ÷ 12	7.5 ÷ 4
FG4-32/160A	0.37	0.5	3 ÷ 13.5	9 ÷ 6
FG4-32/200C	0.55	0.75	3 ÷ 13.5	11 ÷ 8
FG4-32/200B	0.75	1	3 ÷ 15	12.5 ÷ 9
FG4-32/200A	1.1	1.5	3 ÷ 15	14 ÷ 11
FG4-32/200BH	0.55	0.75	3 ÷ 9	11 ÷ 9
FG4-32/200AH	0.55	0.75	3 ÷ 9.6	13.8 ÷ 11
FG4-32/250C	1.1	1.5	3 ÷ 12	18.5 ÷ 13.5
FG4-32/250B	1.5	2	3 ÷ 13.5	21.5 ÷ 15.5
FG4-32/250A	2.2	3	3 ÷ 16.5	24 ÷ 16.5
FG4-40/160C	0.37	0.5	3 ÷ 18	6.5 ÷ 3.5
FG4-40/160B	0.37	0.5	3 ÷ 18	8 ÷ 5
FG4-40/160A	0.55	0.75	3 ÷ 21	9.5 ÷ 5
FG4-40/200B	0.75	1	3 ÷ 21	11.5 ÷ 7
FG4-40/200A	1.1	1.5	3 ÷ 21	13.5 ÷ 10
FG4-40/250C	1.1	1.5	3 ÷ 21	16 ÷ 11.5
FG4-40/250B	1.5	2	3 ÷ 21	17.5 ÷ 13.5
FG4-40/250A	2.2	3	3 ÷ 21	22 ÷ 18
FG4-50/125C	0.37	0.5	9 ÷ 36	4 ÷ 1.5
FG4-50/125B	0.55	0.75	9 ÷ 36	5 ÷ 2
FG4-50/125A	0.55	0.75	9 ÷ 36	6 ÷ 3
FG4-50/160C	0.55	0.75	9 ÷ 30	7 ÷ 4
FG4-50/160B	0.75	1	9 ÷ 33	8 ÷ 5
FG4-50/160A	1.1	1.5	9 ÷ 33	9 ÷ 7
FG4-50/200C	1.5	2	12 ÷ 51	11 ÷ 7.5
FG4-50/200B	2.2	3	12 ÷ 51	13 ÷ 9.5
FG4-50/200A	2.2	3	12 ÷ 54	15 ÷ 11
FG4-50/200AR	3	4	12 ÷ 54	17 ÷ 13
FG4-50/250D	1.1	1.5	9 ÷ 27	12.5 ÷ 8
FG4-50/250C	1.5	2	9 ÷ 27	14.5 ÷ 10.5
FG4-50/250B	2.2	3	9 ÷ 30	18 ÷ 14.5
FG4-50/250A	2.2	3	9 ÷ 30	21 ÷ 18
FG4-50/250AR	3	4	9 ÷ 30	24 ÷ 21

TIPO	MOTORE DA ACCOPIARE		PRESTAZIONI n = 1450 rpm	
	kW	HP	Q m³/h	H metri
FG4-65/125C	0.55	0.75	18 ÷ 54	4 ÷ 2.5
FG4-65/125B	0.75	1	18 ÷ 60	4.5 ÷ 3
FG4-65/125A	1.1	1.5	18 ÷ 66	5.5 ÷ 4.5
FG4-65/160C	1.1	1.5	18 ÷ 66	8 ÷ 5.5
FG4-65/160B	1.5	2	18 ÷ 72	9 ÷ 5.5
FG4-65/160A	2.2	3	18 ÷ 72	10 ÷ 7
FG4-65/200B	2.2	3	6 ÷ 72	10.5 ÷ 7.3
FG4-65/200A	2.2	3	6 ÷ 75	12 ÷ 8.5
FG4-65/200AR	3	4	6 ÷ 78	14 ÷ 10
FG4-65/250C	3	4	12 ÷ 70.5	19 ÷ 13
FG4-65/250B	4	5.5	12 ÷ 75	21.5 ÷ 15.5
FG4-65/250A	5.5	7.5	12 ÷ 78	23.5 ÷ 17
FG4-80/160D	1.5	2	15 ÷ 120	6 ÷ 2.5
FG4-80/160C	2.2	3	15 ÷ 120	7.5 ÷ 3.5
FG4-80/160B	2.2	3	15 ÷ 120	8.5 ÷ 5
FG4-80/160A	3	4	15 ÷ 120	10 ÷ 6
FG4-80/200B	4	5.5	15 ÷ 109.5	14 ÷ 8.5
FG4-80/200A	5.5	7.5	15 ÷ 117	15.5 ÷ 10
FG4-80/250B	5.5	7.5	18 ÷ 108	19 ÷ 13.5
FG4-80/250A	7.5	10	18 ÷ 117	22 ÷ 15
FG4-100/160B-N	2.2	3	24 ÷ 165	8.1 ÷ 2.7
FG4-100/160A-N	3	4	24 ÷ 180	9.2 ÷ 3.2
FG4-100/200C	4	5.5	24 ÷ 139.5	12.5 ÷ 7
FG4-100/200B	5.5	7.5	24 ÷ 147	14 ÷ 8
FG4-100/200A	5.5	7.5	24 ÷ 157.5	15.5 ÷ 9.5
FG4-100/250B	7.5	10	24 ÷ 154.5	18.5 ÷ 12
FG4-100/250A	9.2	12.5	24 ÷ 172.5	22 ÷ 14.5

Q = Portata

H = Prevalenza manometrica totale

Tolleranza delle curve di prestazioni secondo EN ISO 9906 Grado 3B.

FG4-32/160

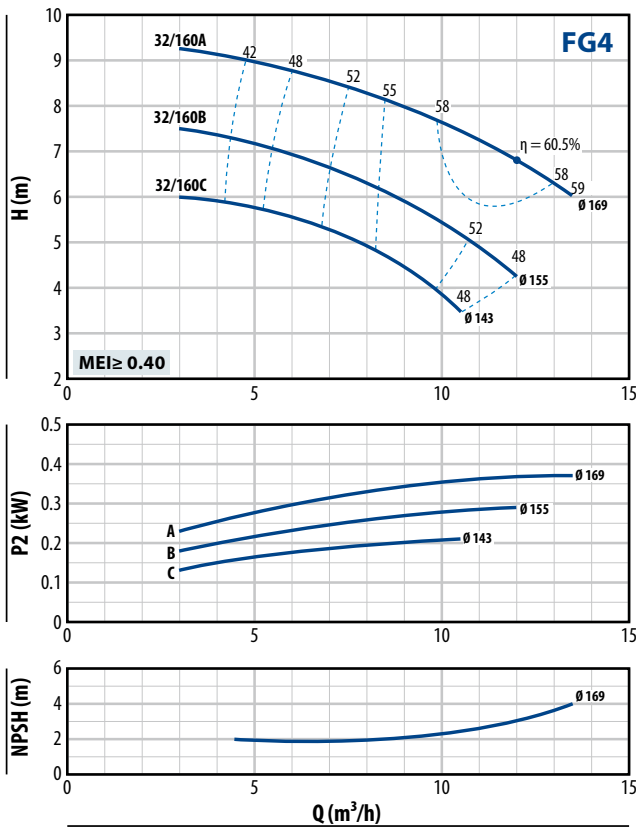

FG4-32/200

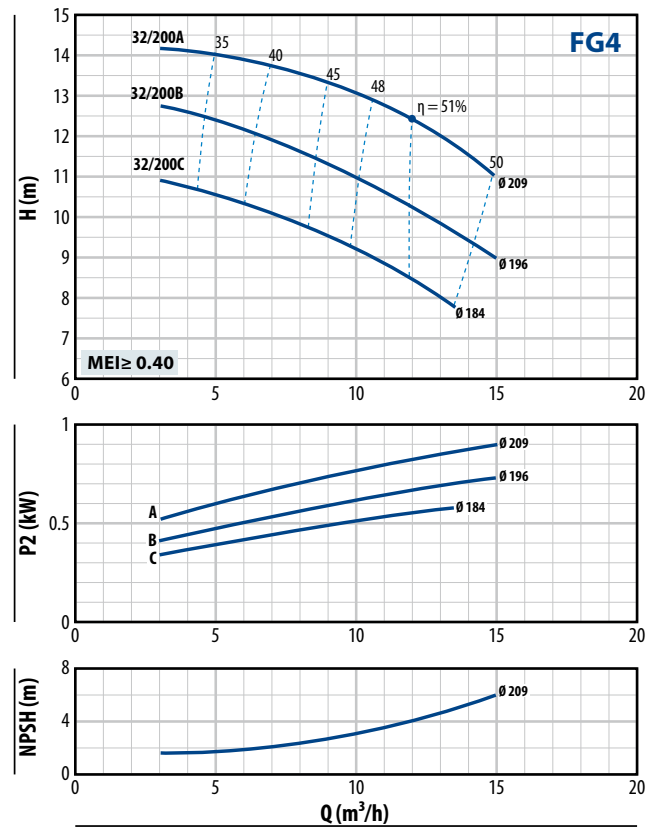

FG4-32/200H

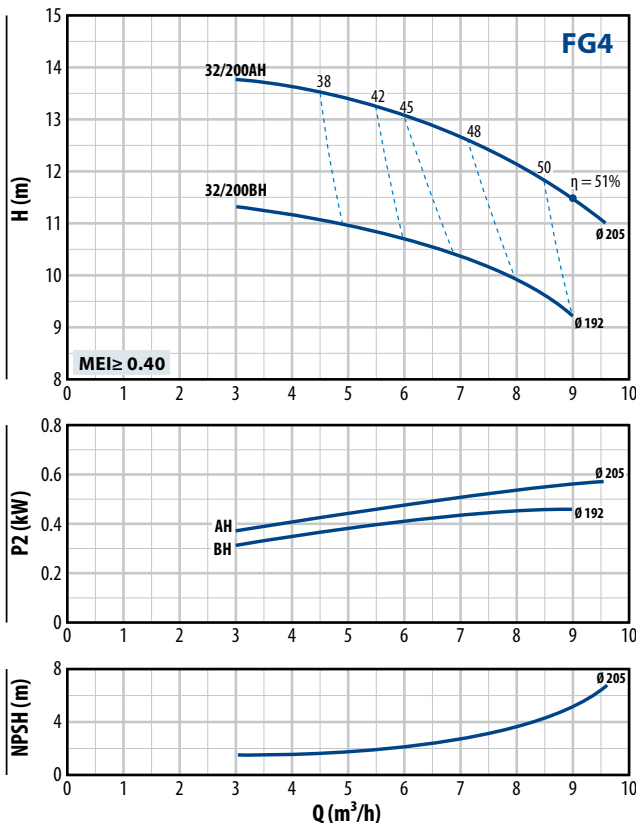

FG4-32/250

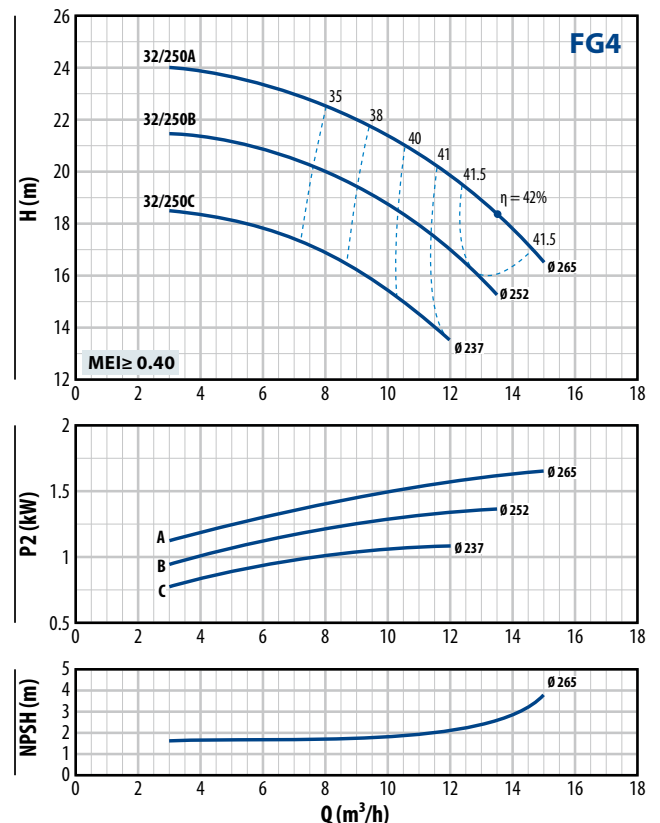

FG4-40/160

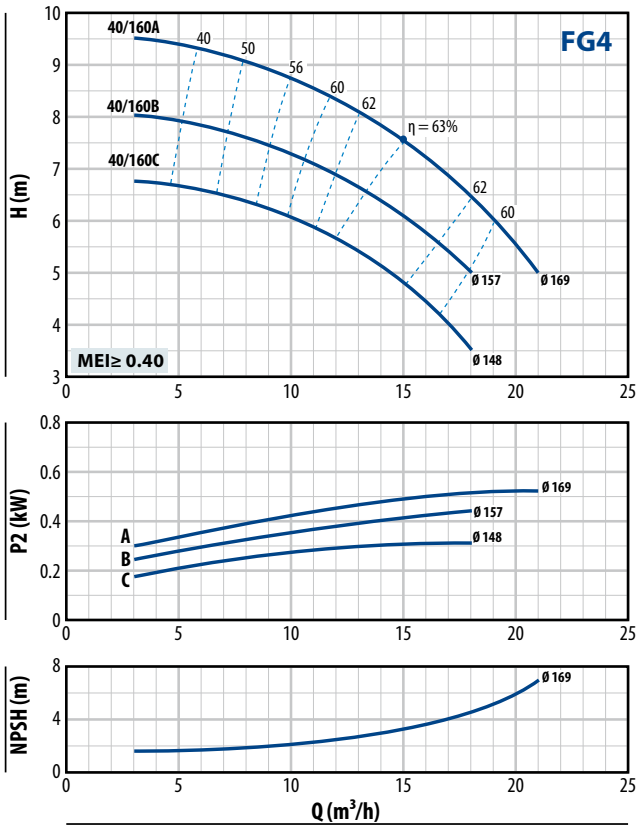

FG4-40/200

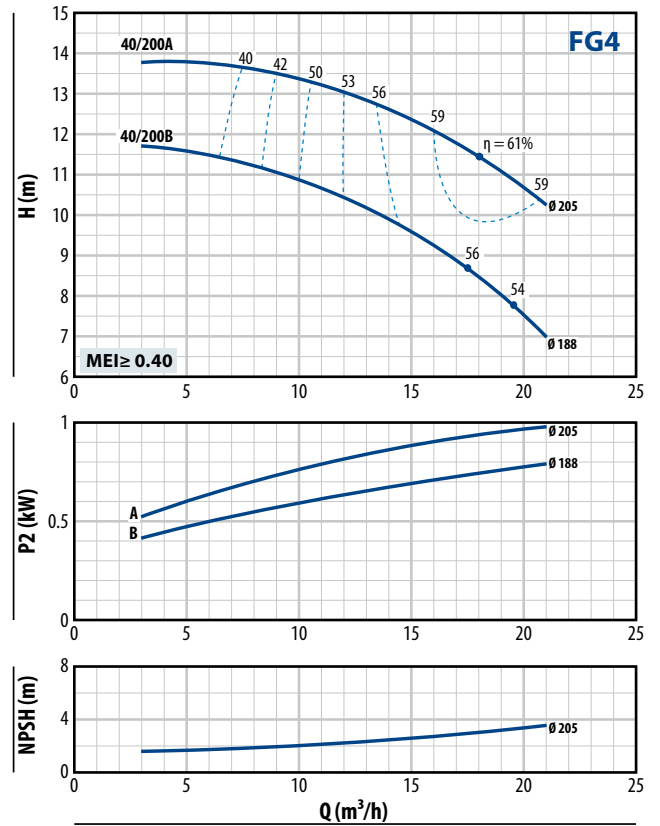

FG4-40/250

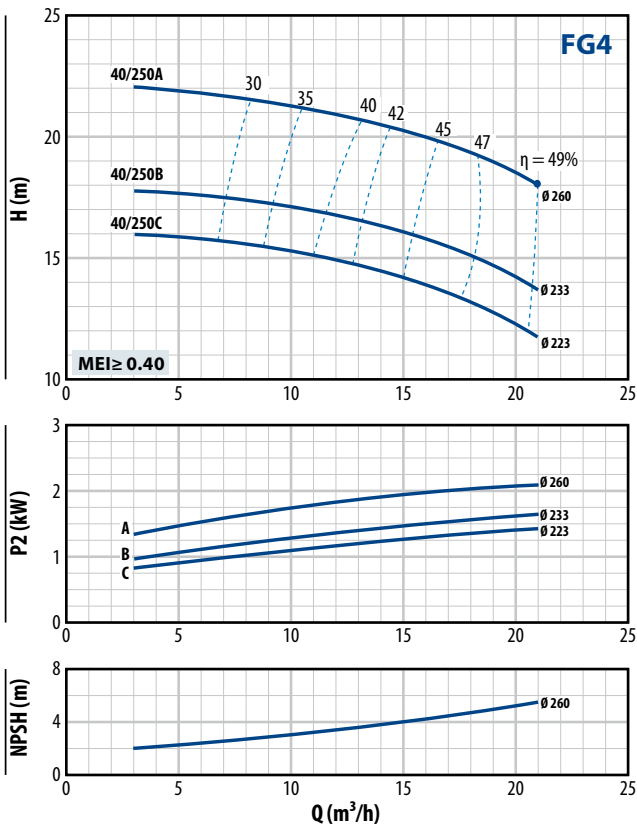

FG4-50/125

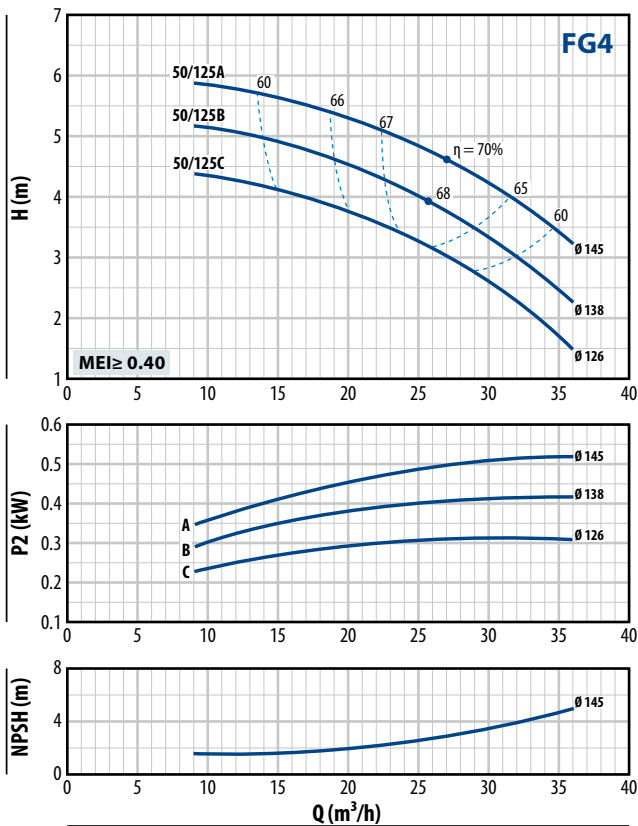

FG4-50/160

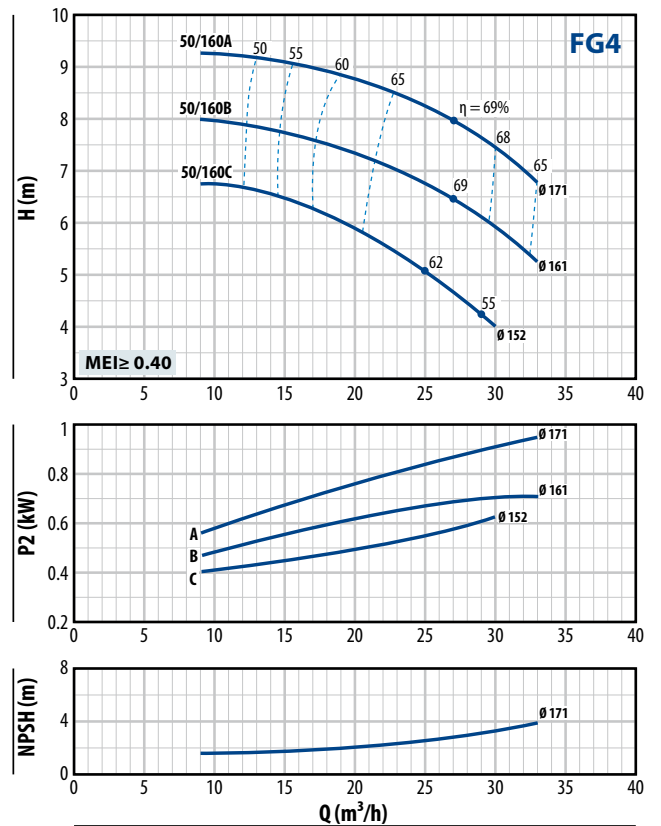

FG4-50/200

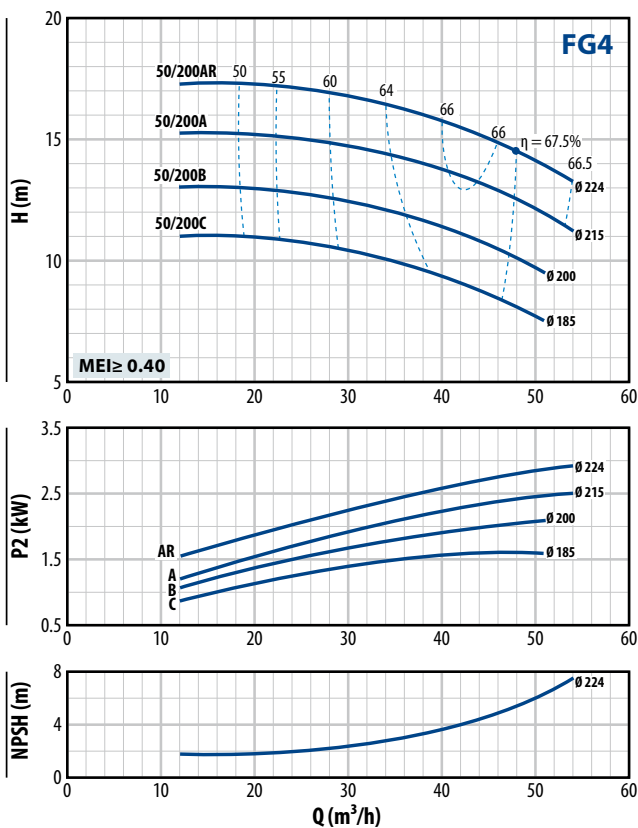

FG4-50/250

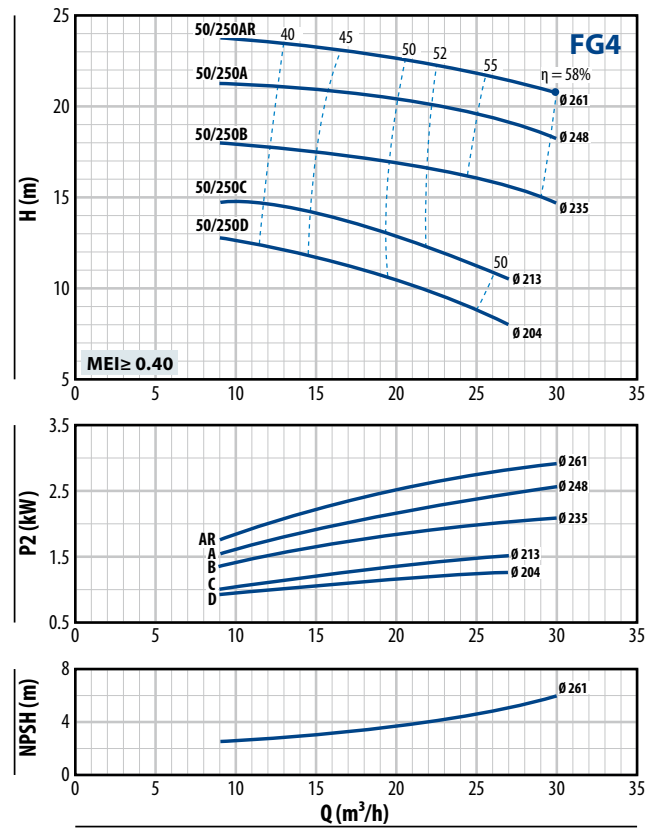

FG4-65/125

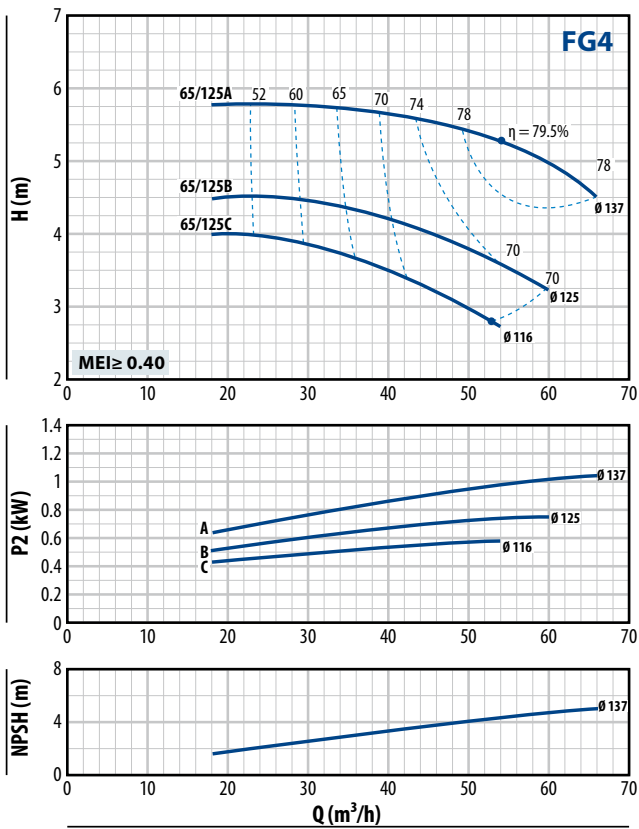

FG4-65/160

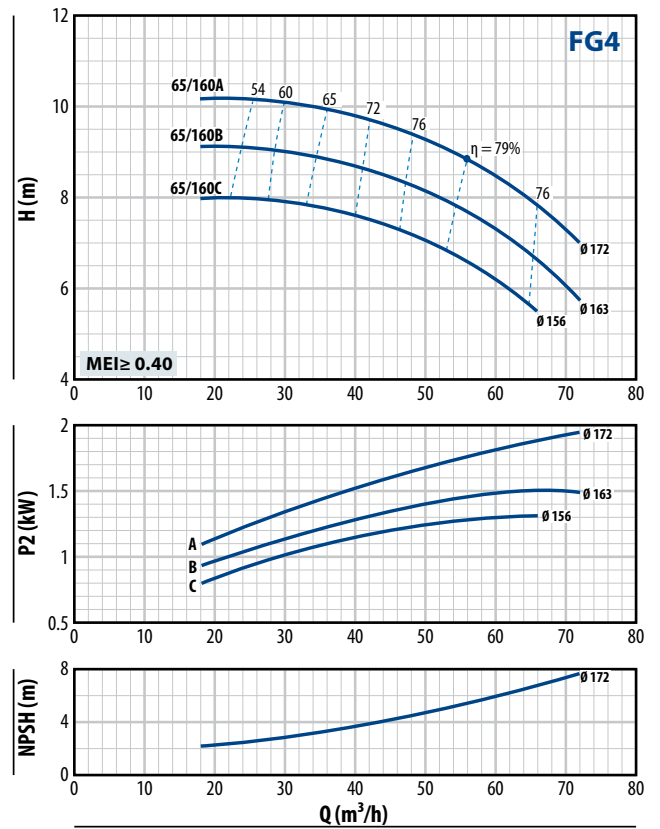

FG4-65/200

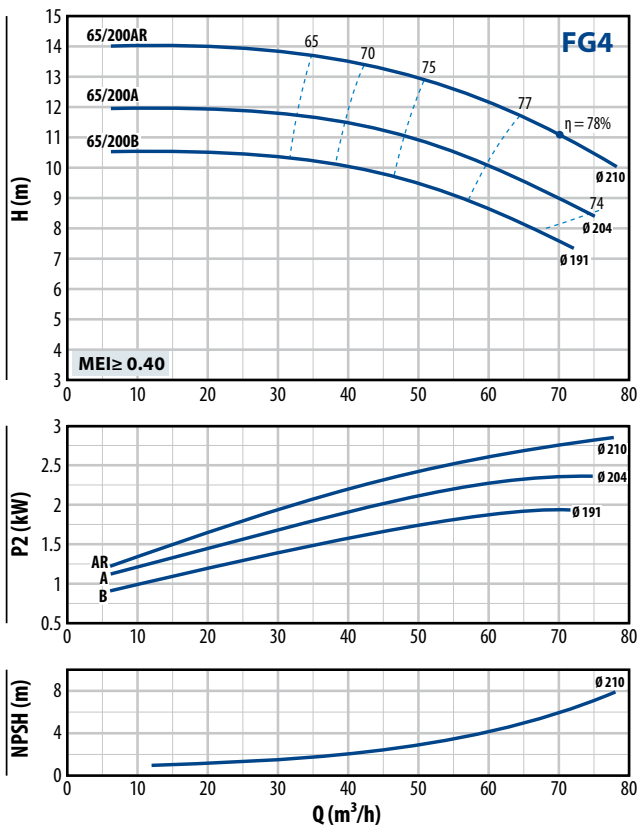

FG4-65/250

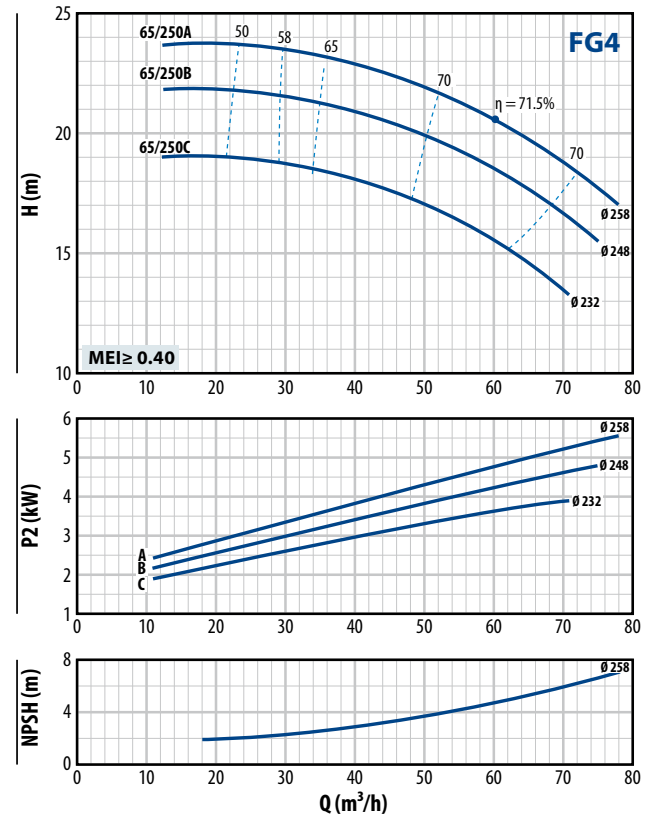

FG4-80/160

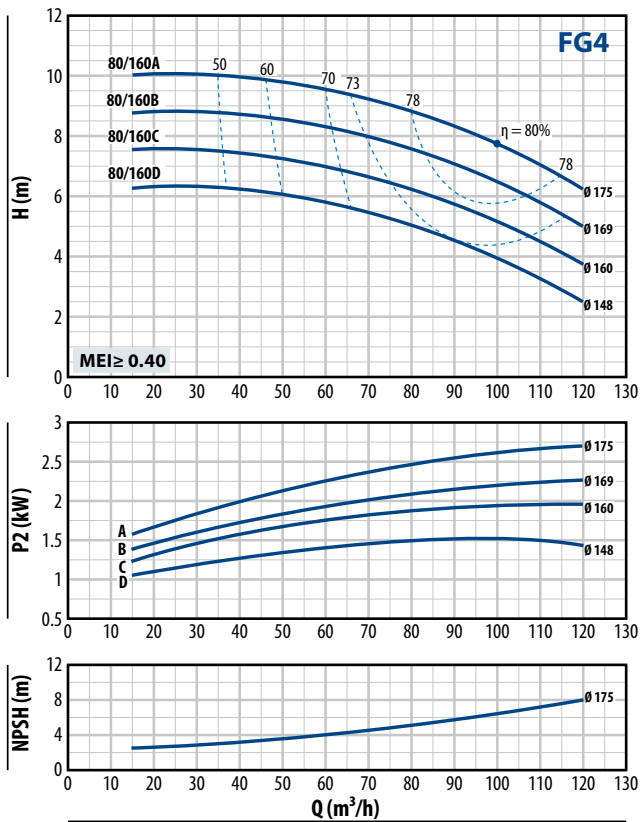

FG4-80/200

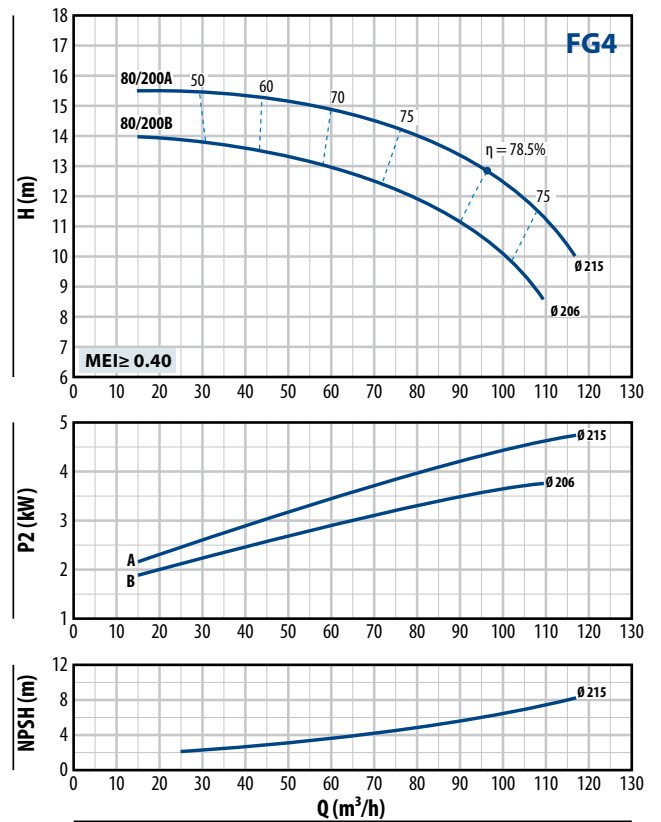

FG4-80/250

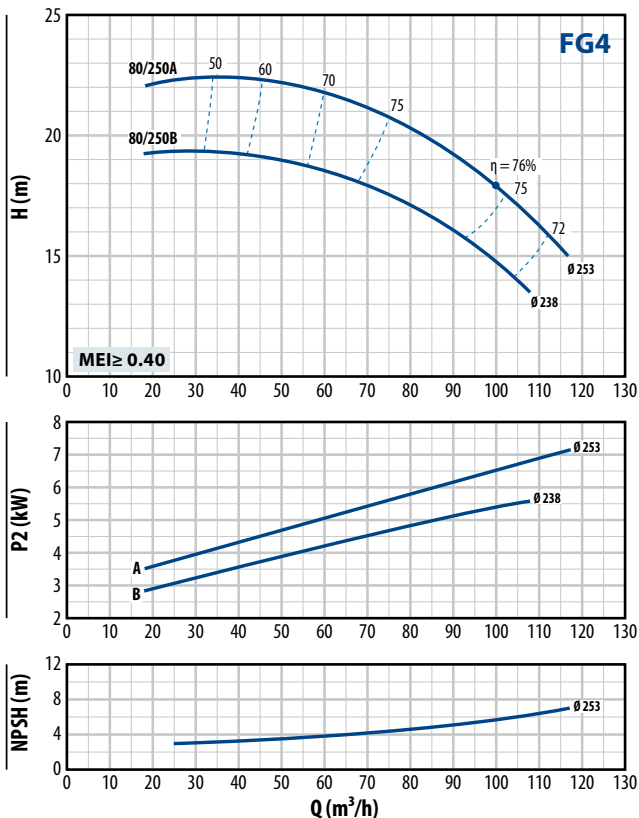

FG4-100/160

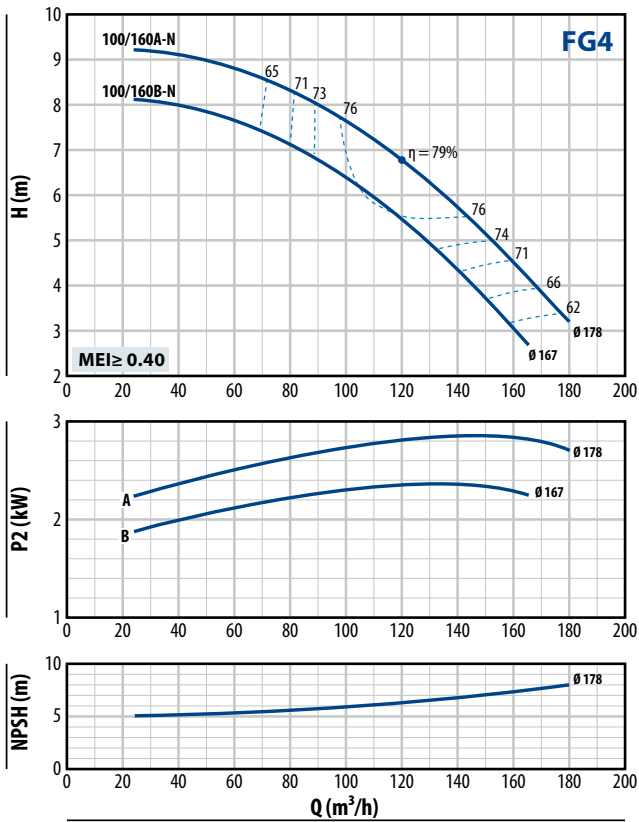

FG4-100/200

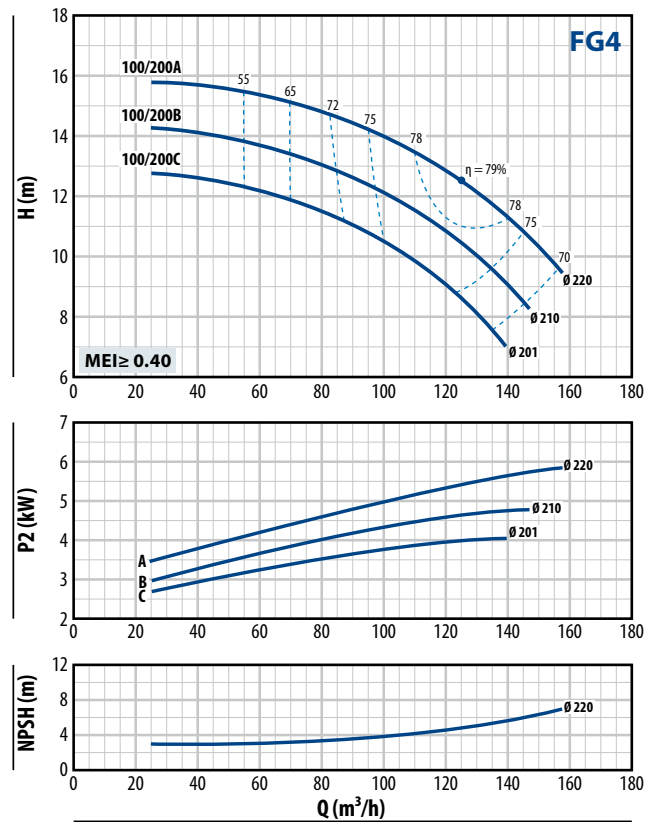

FG4-100/250

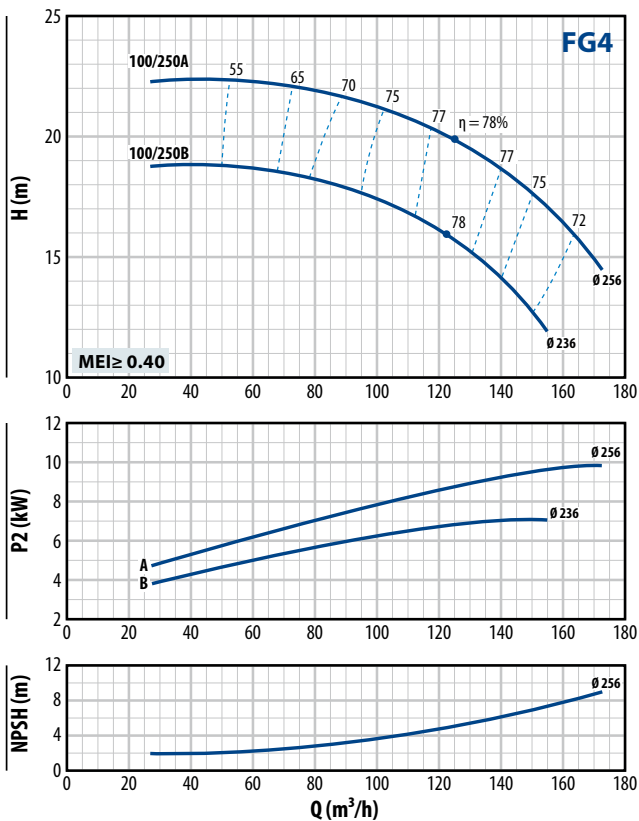

DIMENSIONI E PESI

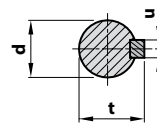
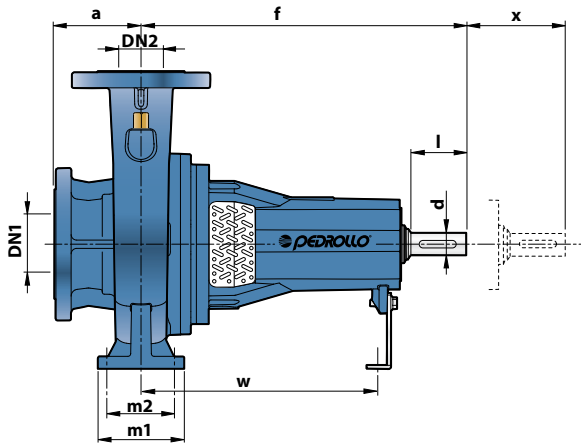

ALBERO mm		
d	u	t
24 k6	8	27
32 k6	10	35

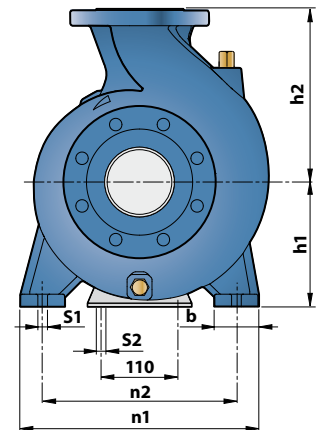

TIPO	DIMENSIONI mm																kg									
	DN1	DN2	a	f	h1	h2	b	m1	m2	n1	n2	s1	s2	w	x	d		l								
FG 32/160	50	32	80	360	132	160	50	100	95	70	240	190	14	260	100	24	50	32	80	71						
FG 32/200					160	180	55	125													95	240	190	32	80	48
FG 32/200H					160	180	55	125													95	240	190	32	80	48
FG 32/250	65	40	80	360	180	225	65	125	95	320	250	14	260	100	24	50	32	80	71							
FG 40/125					112	140	50	100	70	210	160									24	50	34				
FG 40/160					132	160	50	100	70	240	190									24	50	35				
FG 40/200	65	40	80	360	160	180	55	125	95	265	212	14	260	100	24	50	32	80	71							
FG 40/250					180	225	65	125	95	320	250									24	50	58				
FG 50/125					132	160	50	100	70	240	190									24	50	30				
FG 50/160	65	50	100	360	160	180	55	100	70	265	212	14	260	100	24	50	32	80	71							
FG 50/200					160	200	50	100	70	320	250									24	50	45				
FG 50/250					180	225	65	125	95	320	250									24	50	50				
FG 65/125	80	65	100	360	160	180	65	125	95	280	212	14	260	100	24	50	32	80	71							
FG 65/160					160	200	65	125	95	320	250									24	50	45				
FG 65/200					180	225	65	125	95	320	250									24	50	50				
FG 65/250	100	80	125	360	470	200	250	80	160	120	360	280	18	340	140	24	50	32	80	71						
FG 80/160					360	180	225	65	125	95	320	250	14	260	24	50	32	80	48							
FG 80/200					470	180	250	65	125	95	345	280	14	340	32	80	32	80	65							
FG 80/250	100	80	125	360	200	280	80	160	120	400	315	18	260	140	24	50	32	80	71							
FG 100/160-N					360	200	280	80	160	120	360									280	18	24	50	62		
FG 100/200					200	280	80	160	120	360	280									18	24	50	75			
FG 100/250	125	100	140	470	225	280	80	160	120	400	315	18	340	140	24	50	32	80	71							
																				88						

FLANGE DELLE BOCHE

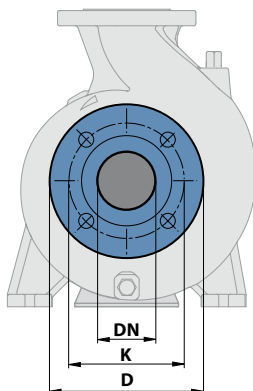

CONTROFLANGE

(ORDINABILI A PARTE)

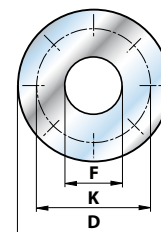

DN FLANGE mm	D mm	K mm	FORI	
			N°	Ø (mm)
32	140	100	4	18
40	150	110		
50	165	125		
65	185	145		
80	200	160		
100	220	180	8	18
125	250	210		

DN FLANGE mm	F CONTROFLANGE	D mm	K mm	FORI	
				N°	Ø (mm)
32	1 1/4"	140	100	4	18
40	1 1/2"	150	110		
50	2"	165	125		
65	2 1/2"	185	145		
80	3"	200	160		
100	4"	220	180	8	18
125	5"	250	210		